

# *PaceMaster* *Gold Elite*



## ***OWNER'S MANUAL***

Manufactured by: Aerobics Inc., 34 Fairfield Place West Caldwell, NJ 07006, (973) 276-9700

[www.pacemaster.com](http://www.pacemaster.com)

Part # TMP1610

Rev. 03/07/06

# TABLE OF CONTENTS



<b>INTRODUCTION</b>	<b>3</b>
<b>IMPORTANT SAFETY INSTRUCTIONS</b>	<b>4</b>
<b>ASSEMBLY INSTRUCTIONS</b>	<b>5-9</b>
Installation Requirements	5
Unpacking Your Treadmill	5
Tools Required for Assembly	5
Grounding Instructions	5
Assembly Instructions	6-8
Testing Your Treadmill	9
<b>THE PACEMASTER GOLD ELITE CONTROL PANEL</b>	<b>10-12</b>
<b>OPERATING INSTRUCTIONS</b>	<b>13-30</b>
Metric Units	13
Setting Your Weight & Age	13
Warm Up and Cool Down	13
Configuring User ID's	14-15
Quick Start	16
Timed Workout (Manual)	17
Fat Burn Workouts	18-19
Fat Burn Workout Profiles	20
Cardio Workouts	21-23
Fitness Evaluator	24
Personal Trainer Workouts	25-29
Personal Trainer Workout Profiles	30
<b>EXCLUSIVE PACEMASTER FEATURES</b>	<b>31-32</b>
Exercise Preview	31
Aerobic Points	31
Personal Electronic Trainer	31-32
<b>CARE AND MAINTENANCE</b>	<b>33</b>
Deck and Tread Belt Cleaning	33
Lubrication	33
Centering the Tread Belt	33
<b>TROUBLE SHOOTING</b>	<b>34-37</b>
Electronic Error Codes	34-35
Elevation Error Codes	35
Hesitation of the Belt	36
Drive Belt Tension Adjustment	36
Tread Belt Tension Adjustment	37
<b>FREQUENTLY ASKED QUESTIONS</b>	<b>38</b>
<b>PACEMASTER TECHNICAL SPECIFICATIONS</b>	<b>39</b>

# INTRODUCTION

Congratulations and thank you for choosing PaceMaster – your partner in achieving your fitness goals and mastering your well-being. PaceMaster’s advanced digital technology allows your treadmill to process information instantly, anticipating and adjusting to meet your needs. Think of it as your own personal trainer.

PaceMaster’s superior components and US manufacture ensure we produce treadmills of the highest quality while also offering excellent value for your dollar. PaceMaster treadmills have consistently received praise from a wide range of nationally recognized publications.

To get the most from your PaceMaster, please read this owner’s manual carefully before starting to use the treadmill. The manual contains important information about the assembly, operation and maintenance of the machine.

Please ensure you read and fully understand all safety information.  **DANGER**,  **CAUTION**, or  **WARNING** indicates important safety warnings throughout the manual. Failure to read and understand these warnings may result in personal injury or damage to your treadmill.

**Tip** indicates a useful suggestion when installing, maintaining or using your treadmill.

Your PaceMaster treadmill is capable of varying your workout by changing speed, incline and time. It can also measure the effect of your workout in a number of different ways. For example “Aerobic Points” (see page 16) is a well tested method to set workout goals based on a desired level of overall fitness. Your PaceMaster treadmill can automatically calculate Aerobic Points for you. In this way your treadmill acts like your own personal trainer.

Please take the time to familiarize yourself with the range of functions available. This will help you work with your PaceMaster treadmill for maximum efficiency to achieve your fitness goals and master your well-being.

We wish you an enjoyable and rewarding partnership with your PaceMaster treadmill.

This treadmill is in compliance with EN 957-2 class H.

**The PaceMaster Gold Elite treadmill is designed for home use only.**

# IMPORTANT SAFETY INSTRUCTIONS

Read these instructions before using your treadmill

 **CAUTION:** Before starting any exercise program, contact your personal physician and have a complete physical. This is highly recommended if you have not been on a regular exercise program within the last year, or are over 35 years of age, or are overweight.

 **CAUTION:** If at any time during your exercise program you find the exercise abnormally difficult or you encounter dizziness, feel faint, experience chest pains, feel as if your heart may be skipping beats, you experience forced heavy breathing after minimal exercise or severe pain in your legs, ankles, knees, etc. STOP EXERCISING and consult your physician.

 **WARNING: To reduce the risk of burns, fire, electrical shock or injury:**

- Never operate your PaceMaster treadmill without clipping the magnetic safety key to your clothing at waist level.
- Your PaceMaster treadmill is not designed for use by children under the age of 18 without strict parental supervision.
- Close supervision is necessary when the treadmill is used by or near children, disabled persons or pets.
- Use your PaceMaster treadmill only for its intended use as described in this manual. Do not use accessories or attachments not recommended by Aerobics, Inc.
- Never operate your PaceMaster treadmill if it has a damaged cord or plug, if it is not operating properly, if it has been dropped or damaged or if it has been immersed in water. Should any of these occur, contact your authorized PaceMaster retailer or service center for examination or repair.
- Keep the cord away from heated surfaces.
- Never drop or insert any object into any opening on the treadmill.
- Do not use outdoors.
- Always unplug your PaceMaster treadmill during an electrical storm or during extended periods of non-use.
- Do not operate where aerosol (spray) products are being used or where oxygen is being administered.
- Position the treadmill with a minimum of 4 feet (1219mm) of clearance between the rear of the treadmill and any wall or obstruction.
- Do not allow anyone to reach under or be too near your PaceMaster while it is in use.
- Do not attempt to mount or dismount the tread belt while it is running.
- Never allow more than one person on your PaceMaster treadmill at any time.
- Never move the treadmill while it is plugged into the electrical outlet.
- When you are finished exercising, leave your PaceMaster treadmill in a non-elevated position to avoid toys and other objects from becoming trapped beneath.
- Wear appropriate running or walking shoes and attire while exercising.
- The treadmill should be turned off after each use by removing the safety magnetic key.
- Never apply lubricant to the belt and deck. It is permanently lubricated at the factory and is maintenance free.

# ASSEMBLY INSTRUCTIONS

## Installation Requirements

Your PaceMaster should be installed indoors on a flat, level surface near a 120Volt/ 15Amp outlet. PaceMaster requires a dedicated, non-switched outlet that is not part of a GFI (Ground Fault Interrupter) circuit, preferably no more than 5 feet from the outlet to eliminate the need for an extension cord. You must have a minimum of 4 feet of clearance between the rear of the treadmill and any wall or obstruction.

**TIP:** If you are installing your PaceMaster on a carpeted surface, use a treadmill mat or a scrap piece of carpet underneath the treadmill to avoid soiling of the carpet. Deep pile carpet is not recommended.

## Unpacking Your Treadmill

The PaceMaster treadmill is packed in five pieces:

- Frame assembly
- Front handlebar assembly with Control Panel
- Two side rails (1 Left, 1 Right)
- Motor cover
- Hardware package
- Polar Heart Rate Transmitter.

Before assembling your treadmill, open the hardware package and verify that the contents of the package match the hardware legend included in the hardware package. NOTE: there will be an extra 3/16" Hex Wrench in the hardware package. If any parts are missing, contact the authorized PaceMaster retailer where you purchased your PaceMaster treadmill.

## Tools Required for Assembly

- 3/16" T – handle Hex wrench (included)
- 7/32" Hex wrench (included)
- Phillips screwdriver (# 2 tip)
- 7/16" combination wrench

## Grounding Instructions

**!** **DANGER:** This product must be properly grounded. If it should malfunction or become inoperable, grounding provides a path of least resistance for electric current to reduce the risk of electric shock. This product is equipped with a cord having an equipment-grounding conductor and a grounding plug. The plug must be plugged into an appropriate outlet that is properly installed and grounded in accordance with all local codes and ordinances. See example to the right.

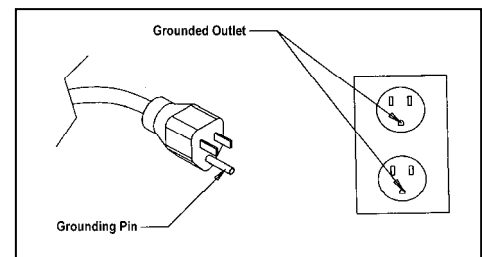

**!** **WARNING:** Improper connection of the equipment grounding-conductor can result in a risk of electrical shock. Check with a qualified electrician or serviceman if you are in doubt as to whether the product is properly grounded. Do not modify the plug provided with the product. If it will not fit the outlet, have a proper outlet installed by a qualified electrician. This product is rated for more than 15 amperes and is for use on a circuit having a nominal rating of 120 volts. It is factory equipped with a specific electric cord and plug to permit connection to a proper electric circuit. Make sure that the product is connected to an outlet having the same configuration as the plug. **No adapter should be used with this product.** Attempting to bypass it with an adapter or in any way defeating its purpose can result in a serious shock hazard.

As a safety precaution, unplug the treadmill during electrical storms or if the treadmill will not be in use for periods greater than one week.

**!** **CAUTION:** If you need to use an extension cord it must be a 14 gauge, three wire cord, no longer than 12 feet.

# ASSEMBLY INSTRUCTIONS

## Assembly

### Step One: (see figure 1)

Carefully lower the handlebar on to its mounting brackets as shown in figure 1. The mounting brackets must slide inside the handle bar. With the handle bar in place install 2 screws (A) with washers into both handlebar uprights as shown, do not tighten these screws yet. Install 2 screws (B) with washers into both handlebar uprights as shown; The following **MUST** be done in the Order it is written.

Tighten the 4 screws (A) as shown in figure 1.

Tighten the 4 screws (B) as shown in figure 1.

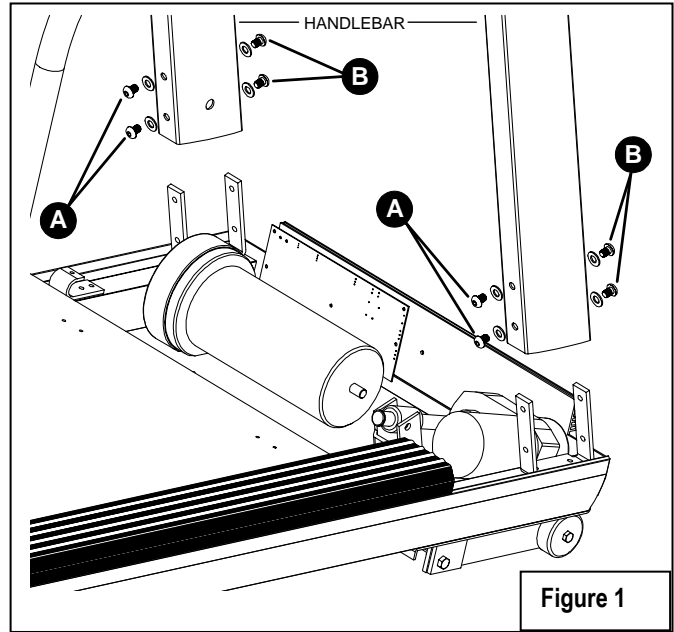

### Step Two: (see figure 2)

Slide the side rail adaptors all the way onto the square handle bar support tube. The side rails are labeled left and right, slide the side rails over the side rail adaptors on their respective sides. The grip on the side rail must slide inside the control panel till it can go no more.

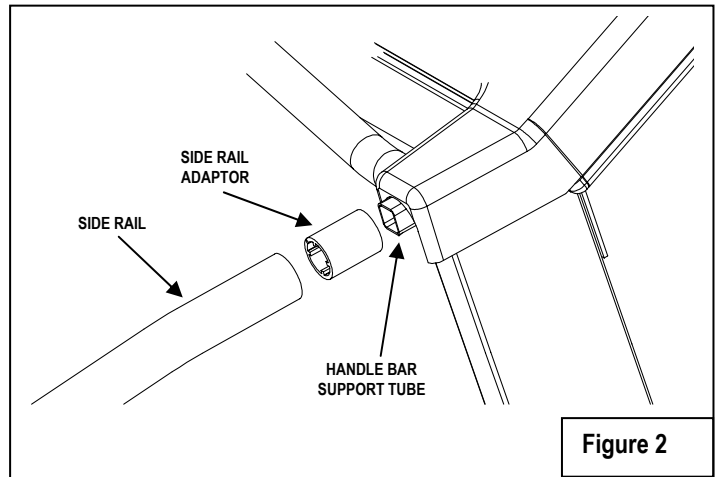

### Step Three: (see figure 3)

Insert carriage bolt (G) through the hole in the bottom of the side rail. Slide the side rail mounting bracket (H) on to the bolt as shown. Push the carriage bolt through the frame rail until it is protruding through the other side. Install the fender washer (I) and the kep nut (J) on the threaded end of the bolt. Tighten the 2 nuts (J) as shown in figure 3.

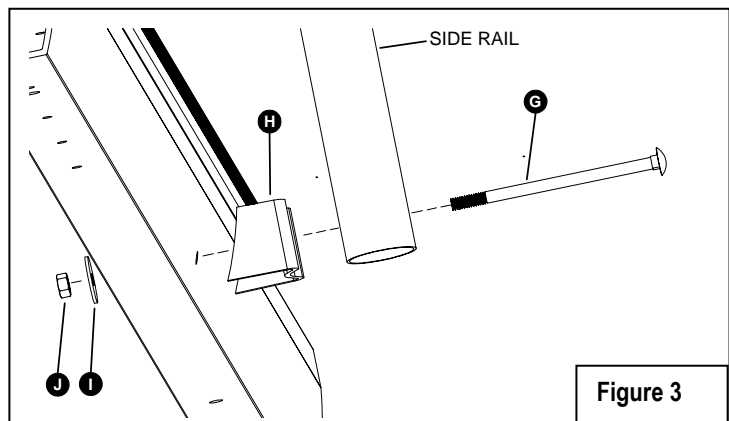

**Step Four:** (see figure 4)

The grip on the side rail must slide inside the control panel till it can go no more. Install the set screws “K” #8 x 1/2” into the predrilled hole on the bottom each side rail as shown in figure 4. You must drive the screw all of the way in.

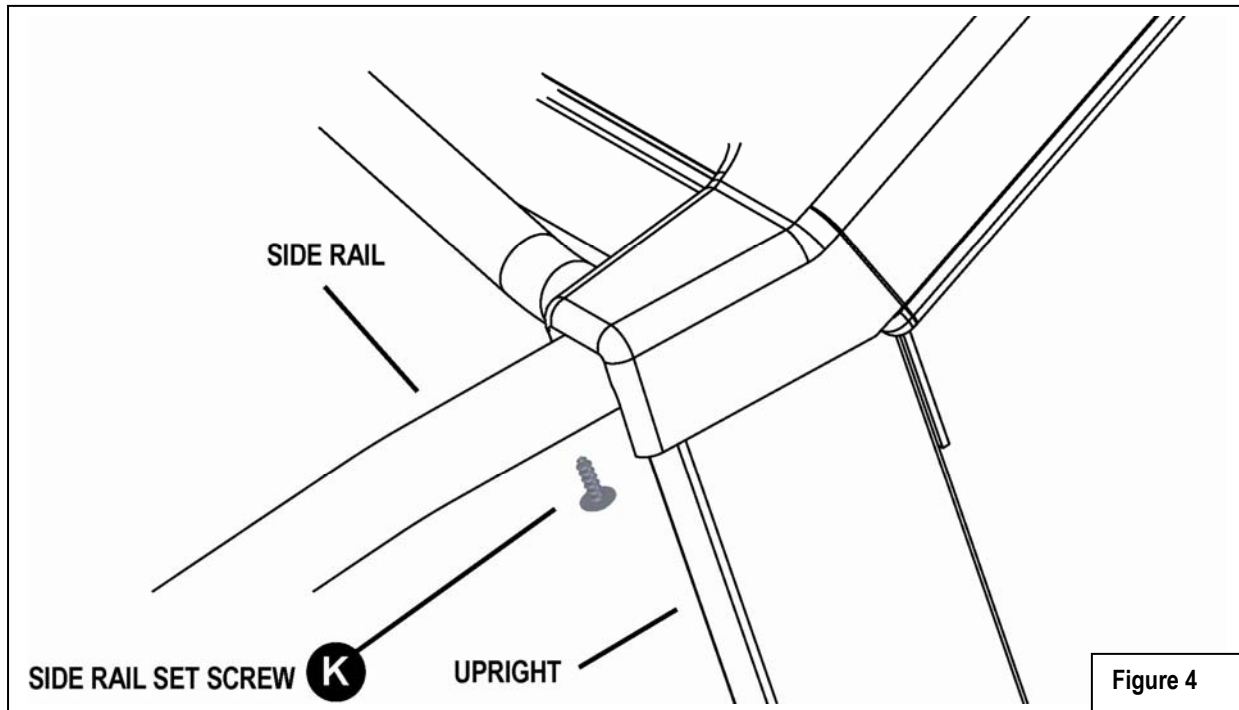

**CAUTION:** The treadmill **MUST** be unplugged.

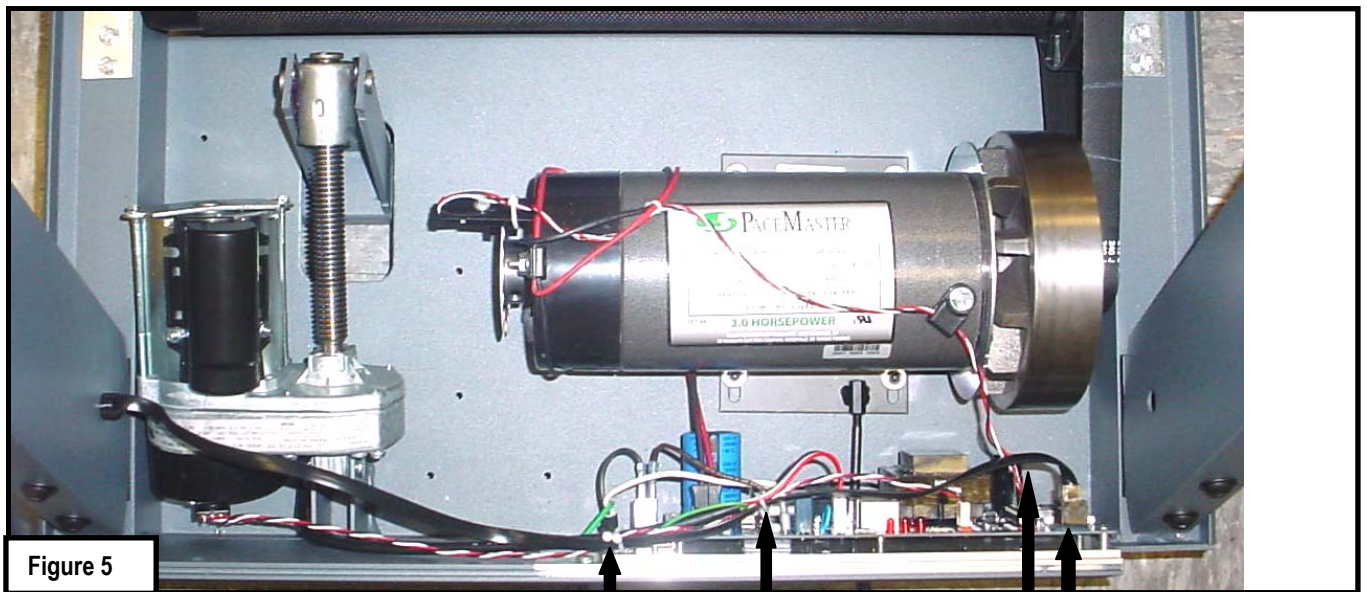

**Step Five:** (see figure 5)

With the handlebar bolted in place, plug the black wire harness (C) into the socket (D) on the power supply board. Twist open the purse lock clip at (E), insert the wire harness (C), confirm the wire harness is positioned as shown at point (D) and twist close the purse lock clip. Follow the same procedure for purse lock clip (F).



**Step Six:** (see figure 6)

Remove the 2 Phillips head screws (L) from the right handle bar upright. Install the water bottle cage using screws (L) as shown in figure 6.

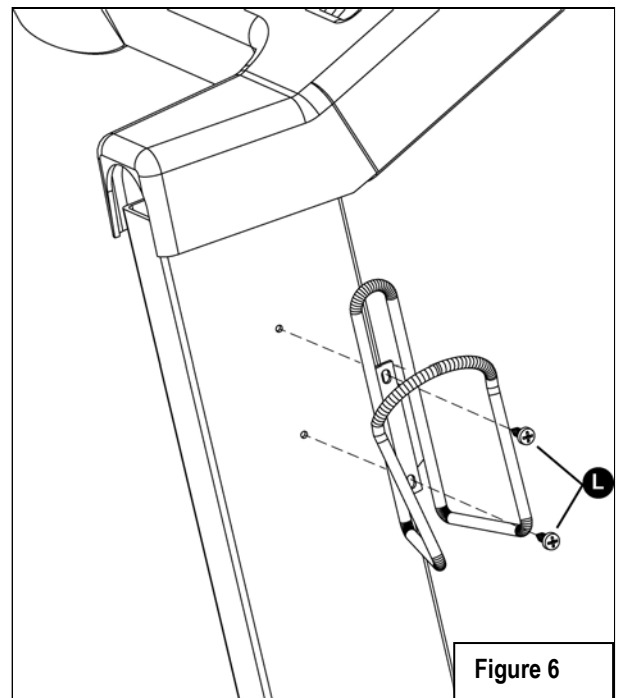

**Step Seven:** (see figure 7)

Position the grey motor cover as shown in figure 7. Use two #8 x 3/8 screws from the hardware kit to secure the motor cover at the two points "M" in fig. 7. Press down at both points "N" to secure the Velcro pads.

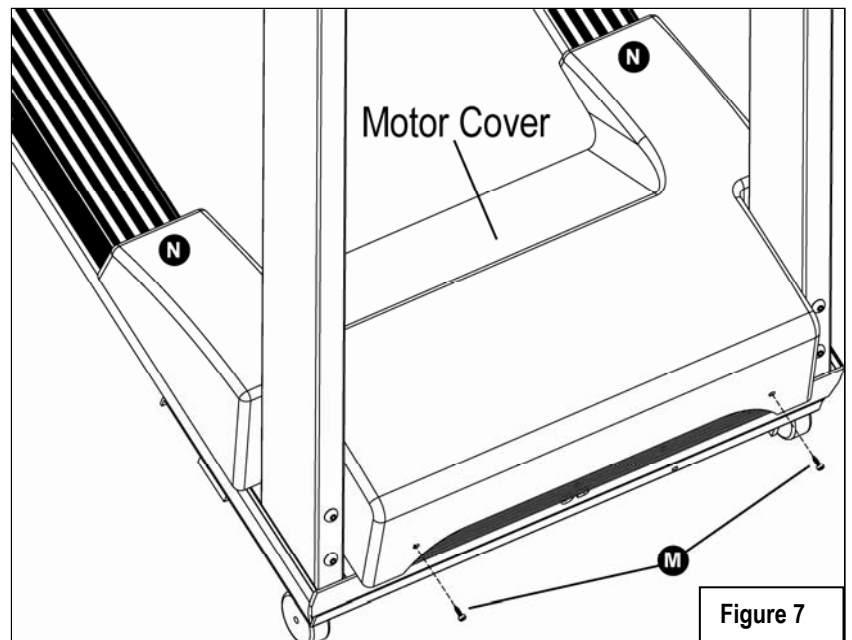



# Testing Your Treadmill





Your PaceMaster has been adjusted and tested at the factory. However, due to changes that can occur during shipment, it should be tested prior to use. Once you have assembled your treadmill and it is located where it will be used, proceed as follows. (Do not make any adjustments unless necessary.) **For the purpose of this test, DO NOT stand on the tread belt. Once tested, always start and finish on the tread belt.**

**Follow the steps below to confirm proper operation of your treadmill after assembly.**

## Step One:

After your treadmill is in place and plugged in to the wall outlet, insert the magnetic safety key into the recess on the control panel.

## Step Two:

Press the Incline   buttons to set your weight and the Speed   buttons to set your age, then press the  button to store your personal information. You can now begin your desired program and the results; total Time, Distance, Calories burned, Aerobic Points earned and Average Speed, for seven workouts will be stored.

## Step Three:

Set the workout speed by pressing the SPEED  button until the SPEED display shows 2.5 mph.



## Step Four:

Press the START  button. Within a few seconds, the tread belt will begin to move. The speed display will flash until the tread belt has reached the set speed.

## Step Five:

After the treadmill has reached 2.5 mph, observe the tread belt to make sure it is reasonably centered. If the tread belt is not reasonably centered, press the STOP  button and refer to “Centering the Tread Belt” in the Care and Maintenance section of this manual. Once the tread belt is reasonably centered, run the treadmill at 2.5 mph for 2 minutes to be sure it remains centered.

## Step Six:

To test the elevation, the tread belt must be moving. Press the incline up  button to raise the elevation to 5% incline. The elevation will be displayed in the INCLINE display window. Once it reaches 5%, press the incline down  button to reduce the incline to 0%. If the treadmill does not elevate, or displays “Err” in the incline display consult the troubleshooting section of this manual.

## Step Seven:

Press STOP  you are now ready to use your treadmill.

# THE PACEMASTER GOLD ELITE CONTROL PANEL

Although your PaceMaster has many advanced features to provide versatility in meeting exercise needs, basic operation is extremely easy. Basic operation involves setting your TIME and SPEED goals, then pressing the START button. Your PaceMaster will gradually accelerate to the set speed, maintain that speed until the timer counts to zero and then gradually come to a complete stop. During your exercise, your time remaining, current speed and incline, distance traveled, calories burned, Aerobic Points earned, heart rate and average speed are displayed.



**MAGNETIC SAFETY KEY** - The MAGNETIC SAFETY KEY, with its red cord and garment clip, is an important safety feature. It is also the ON/OFF switch. To power up your treadmill, first attach the garment clip to your clothing at waist level then insert the MAGNETIC SAFETY KEY into the round recess on the control panel. This MAGNETIC SAFETY KEY provides a means of powering down the treadmill in an emergency situation. This treadmill will not operate unless the MAGNETIC SAFETY KEY is engaged. During exercise, an emergency stop can be made at any time by pulling on the cord to release the key from its slot.

**CAUTION:** Using the key to stop the treadmill is an emergency procedure only! To end your exercise routine normally, press the STOP button or allow the timer to count down to zero. Once the belt has come to a complete stop, remove the MAGNETIC SAFETY KEY to turn off the treadmill. When not in use, store the MAGNETIC SAFETY KEY in a safe place to prevent unauthorized use.

## BUTTONS

**INCLINE ▲ and ▼** – 1) When the safety magnetic key is inserted, the Set Weight LED light will flash, prompting you to set your weight. Use these buttons to adjust weight, then press ENTER. 2) Once the user weight has been entered, use these buttons to increase or decrease INCLINE in 0.5% increments to simulate exercising up hill. INCLINE can be changed at any time during your workout. At the end of your workout, the INCLINE setting will automatically return to 0%.

Note: If the magnetic safety key is removed, the incline will not return to 0%. This automatic feature will only occur if the program time has run out or if the STOP key is pressed.

**SPEED + and -** 1) When the safety magnetic key is inserted, the Set Age LED light will flash, prompting you to set your age. Use these buttons to adjust weight, then press ENTER. 2) Once the user age has been entered, use these buttons to increase or decrease SPEED in 0.1 mph increments. SPEED can be adjusted at any time during your workout.

Note: Because the treadmill's computer controls the SPEED during the warm up and cool down phases of your workout., these buttons are inoperable in those modes.

# THE PACEMASTER GOLD ELITE CONTROL PANEL (cont'd)



**START (QUICK)** – 1) Use this button to QUICK START your workout with the press of one button. 2) In all other program modes, use this button to START your workout after the desired time, speed and incline have been entered.



**STOP (RESET)** – 1) Press this button to end your workout. 2) If pressed when the treadmill is stopped, it will RESET the display.



**PAUSE (ENTER)** – 1) When you insert the magnetic safety key, use this button to ENTER your weight. 2) In all of the FAT BURN, CARDIO, PERSONAL TRAINER or TIMED (MANUAL) workouts, press this key to ENTER the desired workout time. For details, refer to the WORKOUTS section in this manual. 3) During a workout, pressing this button will PAUSE your workout, putting it "on hold". The treadmill and the timer will stop but retains the distance, calories burned, Aerobic Points earned and Average Speed thus far, as well as the speed and incline settings and remaining time. The symbol -P- flashes in the SPEED display to indicate the PAUSE feature has been activated. To resume your workout where you left off, press START. The pause feature is not available in cool down or heart rate control.

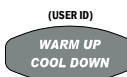

**WARM UP COOL DOWN** – 1) When the magnetic safety key is inserted, press this button to select your User ID #, one through 4, to retain your weight, age and accumulated workout data. 2) Prior to starting your program, this button allows you to add or remove a 5-minute Warm Up and/or 5-minute Cool Down phases of your workout. The WARM UP and/or COOL DOWN indicator LED lights will flash in the PROFILE display window when a WARM UP and/or COOL DOWN mode is selected. 3) During WARM UP, pressing the WARM UP COOL DOWN button discards the remaining Warm Up time and advances you to the main workout phase. During the main workout, pressing the WARM UP COOL DOWN button discards the remaining time and starts the Cool Down phase. For details, refer to the USER ID and/or WARM UP and COOL DOWN section in this manual.



**EXPRESS KEYS** – As an alternative to continually pressing the INCLINE ▲ or

▼ buttons to increase or decrease incline or the SPEED + or - buttons to increase or decrease speed, press these buttons, then the numbered button(s) 0-9 for express changes.



**EXPRESS INCLINE** – For example, if you want to adjust the incline to 10%, press the EXPRESS INCLINE button, then 1, then 0. The incline will automatically increase to 10%. The EXPRESS INCLINE buttons adjust incline in 1.0% increments. To adjust the incline to 8.5%, press EXPRESS INCLINE, then 8. Then press the INCLINE ▲ button to adjust in 0.5% increments.



**EXPRESS SPEED** – For example, if you choose to increase the speed to 5.0 mph, press the EXPRESS SPEED button, then 5, then 0. The speed will automatically be increased to 5 mph. The EXPRESS SPEED buttons adjust speed in 0.1 mph increments. To adjust speed to 5.3 mph, press EXPRESS SPEED, then 5, then 3.



**WORKOUT INTENSITY LEVEL (TIMER)** – 1) In a Timed Workout (Manual), press these buttons to select the desired workout time, adjustable in 1 minute increments. 2) Once a Fat Burn, Cardio or Personal Trainer program has been selected, first press these buttons to set the desired workout time from 20 to 60 minutes, adjustable in 5 minute increments, then press ENTER. Once the time has been entered, use these buttons to select the desired workout intensity level (1 through 9), then press START to begin your workout. For details, refer to the TIMED WORKOUT (MANUAL), FAT BURN, CARDIO and PERSONAL TRAINER sections in this manual.



**FAT BURN** – Press this button to choose one of the four FAT BURN programs, Calorie Coach, Thigh Shaper, Glute Toner or Waist Reducer. For details, refer to the FAT BURN WORKOUT section in this manual.



**CARDIO** – Press this button to choose one of the six CARDIO workouts; Heart Zone Monitor, Target HRC, Fat Burn Zone HRC, Cardio Zone HRC, Interval HRC or Fitness Evaluator. For details, refer to the CARDIO WORKOUT section in this manual. **Note:** The included chest strap must be worn and a heart rate signal must be detected in order for these programs to be operational.



**PERSONAL TRAINER** – Press this button to choose one of the six PERSONAL TRAINER workouts; Hill Intervals, Speed Intervals, Mixed Intervals, Custom 1, Custom 2 or Custom 3. For details, refer to the PERSONAL TRAINER WORKOUTS section in this manual.



**PACE** – Press this button to display speed in *minutes per mile* or *minutes per kilometer* when in Metric mode. When the PACE button is pressed, the current PACE will be displayed for 5 seconds in the TIME display window, then the display will revert back to elapsed or remaining time.

# THE PACEMASTER GOLD ELITE CONTROL PANEL (cont'd)



**SELECT** – 1) Prior to beginning your workout, press this button to see the predicted distance, caloric expenditure, Aerobic Points and average speed for the workout you have chosen. 2) During workout, press this button to lock onto the desired feedback you want displayed; Distance, Calories, Aerobic Points, Heart Rate (if the included chest strap is worn) or Average Speed. 3) To scan your workout results while exercising, press and hold this button until the word “SCAN” appears in the RESULTS display window. Each value will be displayed for 3 seconds. 4) Press this button to change between English units and Metric units. For details, refer to the METRIC UNITS section in this manual.

## DISPLAYS

**TIMER** – This window displays the chosen workout time in minutes and seconds (mm:ss) up to 59 minutes and 59 seconds. Times of 1 hour to a maximum of 4 hours are displayed as hours and minutes (-h: mm), with the dash as the first digit. For example, one hour and 15 minutes is displayed as -1:15. In QUICK START, the TIMER will count up, displaying the elapsed time. In all other program modes, the TIMER will count down, displaying the remaining time. If a Warm Up and/or Cool Down mode is chosen, the TIMER will display as a 5-minute countdown for the warm up phase, a countdown for the main exercise phase and then a 5-minute countdown for the cool down phase.

**PROFILE** – This window displays the program PROFILE of the chosen Fat Burn, Cardio, Personal Trainer program. In Quick Start, the PROFILE displays a quarter mile track. In a Timed (Manual) program, the PROFILE displays a OneLap track. For details, refer to the OneLap Track section in this manual.

**RESULTS** – 1) Prior to pressing the START button, the RESULTS window will display the predict results of that workout, based on the chosen time and intensity (level). 2) During the workout, this window displays the current distance, caloric expenditure, Aerobic Points, heart rate (if the included chest strap is being worn) and the average speed. The current result displayed in the RESULTS window will be indicated by an illuminated LED light.

**SPEED** – This window displays SPEED from 0.5 mph to 12.0 mph. Prior to beginning a workout, the starting SPEED is displayed. Once your workout has begun, the current SPEED is displayed.

**INCLINE** – This window displays INCLINE from 0% to 15.0%. Prior to beginning a workout, the starting INCLINE is displayed. Once your workout has begun, the current INCLINE is displayed.

## INDICATOR LED LIGHTS

**Set Weight** – Within seconds of the magnetic safety key being inserted, the SET WEIGHT LED indicator light flashes and the last entered weight appears in the INCLINE display window. Weight can be adjusted by pressing the INCLINE ▲ or ▼ buttons. Once your weight is displayed, press PAUSE (ENTER).

**Set Age** – Within seconds of the magnetic safety key being inserted, the SET AGE LED indicator light flashes and the last entered age appears in the SPEED display window. Age can be adjusted by pressing the SPEED + or - buttons. Once your age is displayed, press PAUSE (ENTER).

**INCLINE Max** – The INCLINE Max LED indicator light is illuminated when a Fat Burn, Cardio, Personal Trainer workout is selected. The number displayed in the INCLINE display window is the maximum incline that will be encountered for the program and level chosen.

**SPEED Max** – The SPEED Max LED indicator light is illuminated when a Fat Burn, Cardio, Personal Trainer workout is selected. The number displayed in the SPEED display window is the maximum speed that will be encountered for the program and level chosen.

**WARM UP and COOL DOWN** – The WARM UP and/or COOL DOWN indicator LED lights will flash in the PROFILE display window when a WARM UP and/or COOL DOWN mode is selected.

**RESULTS** – The specific result, Distance, Calories, Aerobic Points, Heart Rate (if the included chest strap is worn) and Average Speed being displayed in the RESULTS display window will be indicated by an illuminated LED light.

# OPERATING INSTRUCTIONS

Initially, you may want to keep both hands on the side rails until you feel comfortable walking on your PaceMaster. Once you feel comfortable, try removing your hands to let them swing naturally, as you would when walking outdoors. Always hold on to the side rail or front handle bar with one hand when operating the buttons of the control panel.

## THE FIRST STEP

Stand on the center of the treadmill belt. Attach the garment clip on the end of the magnetic safety key to your clothing at waist level. Insert the safety key into the recess on the control panel keyboard.

## METRIC UNITS

PaceMaster treadmills can be configured to operate in English (lbs, mph, and miles) or Metric units (kg, kph, and kilometers) of measure. To determine the present configuration of your PaceMaster insert the magnetic key, if "USA" is displayed in the "RESULTS" window it is configured in English, if "Eur" is displayed in the "RESULTS" window, it is configured in Metric. To change between English and Metric insert the magnetic key, as soon as the current setting (USA or EUR) is displayed in the Results window, press and hold the SELECT (PREVIEW) button until the setting changes. Press PAUSE (ENTER) to confirm the selection.

## SETTING YOUR WEIGHT AND AGE

Your PaceMaster calculates caloric expenditure based on the formula developed by the American College of Sports Medicine. To ensure accuracy, your weight is required. Once the magnetic key has been inserted, the default weight of 150 lbs. (68 kg.) is shown in the INCLINE display and the SET WEIGHT indicator will be blinking. By pressing the INCLINE up or down buttons, you will increase or decrease the weight value, press PAUSE (ENTER) when done.

## WARM UP AND COOL DOWN

By warming up prior to beginning the aerobic phase of your workout, you accomplish 2 goals; you stretch and warm up the muscles of the back and extremities and create a slight acceleration of the heart rate so that the body can move gradually into the higher heart rate of the aerobic phase. The aerobic phase should be followed by a minimum 5-minute cool down in which you keep moving at a slower pace. This allows your heart rate to gradually decline and your body to gently adjust to the end of a workout instead of abruptly stopping. The cool down phase also allows blood to be pumped from the lower extremities back to the central circulatory system. Simply put, the function of warming up and cooling down is to ease you from a resting state into an active state and back to a resting state.

The treadmill's computer, based on your main exercise starting and finishing speeds respectively, automatically calculates warm up and cool down speeds.

When in the warm up mode, the TIME display window counts down from 5 minutes and the Warm Up indicator light will blink. When in the Cool Down mode, the TIME display window counts down from 5 minutes and the Cool Down indicator light will blink.

To add warm up and/or cool down to a TIMED workout press the Warm Up / Cool Down button. The indicator light will blink, indicating that the desired mode has been added to your workout. You will also notice that the workout time increases by 5 minutes for each addition.

To shorten the warm up mode, press the Warm Up / Cool Down button once. Warm up will be ended and you will advance into the main exercise. To shorten the main exercise, press the Warm Up / Cool Down button and you will automatically begin the cool down phase. To end the cool down, press STOP and your session will come to a close.

A cool down phase can be added to any workout (even if it wasn't chosen prior to beginning the workout) by pressing the Warm Up / Cool Down button.

Now you are ready to choose your workout mode. Whether it is Quick Start, Timed Workout (Manual), or one of the four Variable Intensity Workouts, the following pages give you step-by-step instructions on how to use each workout.

# CONFIGURING USER ID'S

The four USER ID positions give you the ability to view the results from your last seven workouts. They can be recalled as a cumulative total or as individual workouts.



## Selecting and setting a USER ID

### Step One:

Stand on the running belt and attach the garment clip on the end of the magnetic safety key to your clothing. Insert the safety key into its recess on the control panel.

**Step Two:** Select a USER ID number by pressing the **(USER ID) WARM UP COOL DOWN** button. The default settings for all USER ID positions are 150 lbs. for the weight and 40 years for the age.

### Step Three:

Press the Incline **▲ ▼** buttons to set your weight and the Speed **+ -** buttons to set your age, then press the **PAUSE (ENTER)** button to store your personal information. You can now begin your desired program and the results; total Time, Distance, Calories burned, Aerobic Points earned and Average Speed, for seven workouts will be stored.

### Step Four:

Prior to beginning each workout, you must remove and re-insert the magnetic safety key as described in Step One for the results will be stored. Press the **(USER ID) WARM UP COOL DOWN** button until your USER ID number is displayed in the PROFILE display window, then press the **PAUSE (ENTER)** button.

## Recalling the cumulative summary of your last seven workouts

### Step One:

Stand on the running belt and attach the garment clip on the end of the magnetic safety key to your clothing. Insert the safety key into its recess on the control panel.

**Step Two:** Press the **(USER ID) WARM UP COOL DOWN** button until your USER ID number is displayed in the PROFILE display window. Press the **SELECT** button to scroll through a cumulative summary of the results from your last seven workouts.

## Recalling the individual workout results from your last seven workouts:



### Step One:

Stand on the running belt and attach the garment clip on the end of the magnetic safety key to your clothing. Insert the safety key into its recess on the control panel.

### Step Two:

Press the  button until your USER ID number is displayed in the PROFILE display window.

### Step Three:



Use  buttons to scroll through the summaries for your last seven workouts. Press  button to get back to the USER ID display or press  button to begin the desired program.

## To recall and use your last workout settings:

### Step One:

Stand on the running belt and attach the garment clip on the end of the magnetic safety key to your clothing. Insert the safety key into its recess on the control panel.

### Step Two:



Press the  button until your USER ID number appears in the PROFILE display window, then press the Pause  button. Your last workout settings will be displayed. Press the  to begin that program.

## Resetting your cumulative data:

### Step One:

Stand on the running belt and attach the garment clip on the end of the magnetic safety key to your clothing. Insert the safety key into its recess on the control panel.

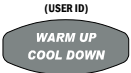
### Step Two:

Press the  button until your USER ID number appears in the PROFILE display window. Press and hold the  button until 0:00 appears in the TIMER display window and 0.00 appears in the RESULTS display window.

# QUICK START





Quick Start allows you to begin your workout by pressing one button. You control the speed, incline and time.

## Step One:

Stand on the running belt and attach the garment clip on the end of the magnetic safety key to your clothing. Insert the safety key into its recess on the control panel.

**TIP:** If you have selected your user ID, go to Step Three.

## Step Two:

Press the Incline   buttons to set your weight and the Speed   buttons to set your age, then press the





 button to store your personal information. You can now begin your desired program and the results; total Time, Distance, Calories burned, Aerobic Points earned and Average Speed, for seven workouts will be stored.

**NOTE:** If you are wearing your Heart Rate chest strap and would like to use the Heart Zone Monitor feature Press the  button, C1 will appear in the results window, this activates the Heart Rate receiver.

## Step Three:

Press the  button. Within a few seconds, the tread belt will begin to move. The speed display will flash until the tread belt has reached the set speed.

## During your Workout:

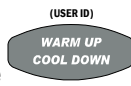
- Adjust the speed at any time during your workout by pressing the Speed   buttons. Speed will adjust in 0.1 mph increments
- Add incline at any time during your workout by pressing the Incline   buttons. Elevation will adjust in 0.5% increments.
- Add a 5 minute Cool Down to the end of your workout by pressing the  button when you are ready.

**TIP:** You can pause your workout by pressing the PAUSE  button. This feature is not available in cool down or heart rate control.

To resume, press the START  button.

**TIP:** During your workout you can press and hold the  button until the word “SCAN” appears, each value (distance, calories, Aerobic Points, Heart Rate, and Average Speed) will now be displayed for 3 seconds on a rotating cycle.

## Step Four:

To end your workout, press the  button. The treadmill will display the total time, calories, Aerobic Points, distance and average speed.

If a problem should occur, your PaceMaster can be stopped quickly by pulling on the magnetic safety cord to dislodge the key from the control panel. The treadmill will stop a bit more abruptly, but still gently enough to prevent you from being injured. **This is an emergency procedure only and should not be used as the normal stopping procedure.**



# TIMED WORKOUT (MANUAL)





Timed Workout allows you to choose the length of time and the degree of intensity for your workout. You can make speed and incline adjustments at any time during the workout.



## Step One:

Stand on the running belt and attach the garment clip on the end of the magnetic safety key to your clothing. Insert the safety key into its recess on the control panel.

**TIP:** If you have selected your user ID, go to Step Three.

## Step Two:



Press the Incline   buttons to set your weight and the Speed   buttons to set your age, then press the  button to store your personal information. You can now begin your desired program and the results; total Time, Distance, Calories burned, Aerobic Points earned and Average Speed, for seven workouts will be stored.



**NOTE:** If you are wearing your Heart Rate chest strap and would like to use the Heart Zone Monitor feature Press the  button, C1 will appear in the results window, this activates the Heart Rate receiver, now press  and continue below.

## Step Three:

Enter the starting speed by press the Speed  button until the desired speed appears in the SPEED display window. Speed can be adjusted at any time during your workout.

## Step Four:

Enter the workout time using the   buttons until the desired workout time appears. If you hold either of the buttons down the time scrolls quickly.

- If you wish to include warm up and/or cool down to your workout, press the  button until the indicator light next to the desired mode is illuminated. You will notice that your workout time will automatically increase by 5 minutes for each addition. For details, refer to the WARM UP AND COOL DOWN section in this manual.
- Adjust incline by pressing the Incline   buttons. Elevation is adjusted in 0.5% increments.

## Step Five:

Press  and your PaceMaster will gradually accelerate until it reaches the entered speed.

## Step Six:

To end your workout, either allow the timer to count down to zero or press the  button. The treadmill will display the total time, calories, Aerobic Points, distance and average speed.

**TIP:** You can pause your workout by pressing the PAUSE  button. This feature is not available in cool down or heart rate control. To resume, press the START  button.

**TIP:** During your workout you can press and hold the  button until the word “SCAN” appears in the RESULTS display, each value (distance, calories, Aerobic Points, Heart Rate, and Average Speed) will now be displayed for 3 seconds on a rotating cycle.

# FAT BURN WORKOUTS

To assist you in reaching your fitness goals, your PaceMaster comes with 4 Fat Burn Workouts- F1 Calorie Coach, F2 Thigh Shaper, F3 Glute Toner, and F4 Waist Reducer. F2, F3, and F4 each offer 9 different levels of intensity, giving you 27 different workout possibilities. Additionally, each Fat Burn workout is time adjustable from 20 to 60 minutes. During your workout, you will be alerted to all speed and/or elevation changes in the workout with 4 audible chirps and a flashing speed and/or incline display.

## F1 CALORIE COACH

The Calorie Coach program enables you to select the number of calories you want to burn. Then, based on the speed and incline you enter, the treadmill's computer will determine the time required to achieve your calorie expenditure goal.





## USING F1 CALORIE COACH:

### Step One:

Stand on the running belt and attach the garment clip on the end of the magnetic safety key to your clothing. Insert the safety key into its recess on the control panel.

**TIP:** If you have selected your user ID, go to Step Three.

### Step Two:

Press the Incline   buttons to set your weight and the Speed   buttons to set your age, then press the  button to store your personal information. You can now begin your desired program and the results; total Time, Distance, Calories burned, Aerobic Points earned and Average Speed, for seven workouts will be stored.

### Step Three:

If you are wearing your Heart Rate chest strap and would like to use the Heart Zone Monitor feature Press the  button, C1 will appear in the results window, this activates the Heart Rate receiver.

### Step Four:

Press the  button once and F1 will appear in the RESULTS window. A mug will appear in the Profile display window and number (example: C100) will appear in the RESULTS display window. C100 represents 100 calories. This number will vary with user selected variables.

### Step Five:

Use the  buttons set the number of calories you want to burn; this is displayed in the RESULTS window.

### Step Six:

Set the speed and incline you desire. The treadmill will automatically calculate the amount of exercise time necessary to achieve the selected caloric expenditure.

### Step Seven:

Press , you will be in the warm-up phase, you will see the warm-up steps in the PROFILE display window. . Following the warm up phase, you will see the OneLap™ Track in the PROFILE display window. The RESULTS window will show a count up of the calories burned thus far.

**TIP:** You can pause your workout by pressing the  button. This feature is not available in cool down or heart rate control.

To resume, press the  button.





## USING F2, F3, and F4:

### Step One:

Stand on the running belt and attach the garment clip on the end of the magnetic safety key to your clothing. Insert the safety key into its recess on the control panel.

**TIP:** If you have selected your user ID, go to Step Three.

### Step Two:

Press the Incline   buttons to set your weight and the Speed   buttons to set your age, then press the  button to store your personal information. You can now begin your desired program and the results; total Time, Distance, Calories burned, Aerobic Points earned and Average Speed, for seven workouts will be stored.



### Step Three:

If you are wearing your Heart Rate chest strap and would like to use the Heart Zone Monitor feature Press the  button, C1 will appear in the results window, this activates the Heart Rate receiver.

### Step Four:

In the PROFILE window press the  button to select F2 Thigh Shaper, F3 Glute Toner, or F4 Waist Reducer, the program number (F2, F3, or F4) will be displayed in the RESULTS window.

### Step Five:

The default workout time of 30:00 minutes will be flashing in the TIMER display. Use the   buttons to adjust your total workout time. Total workout time can be set from 20 to 60 minutes, in 5 minute increments; this includes a warm up & cool down.



**TIP:** Warm up and cool down periods are automatically added to all the Variable Intensity Workouts. If you wish to remove the warm up



and/or cool down phases, press the warm up/cool down button  until the corresponding indicator light is no longer illuminated.

### Step Eight:

Press the  button to enter your workout time.

### Step Nine:

Press the   button to adjust the level of intensity. The level will be displayed in the RESULTS display window preceded with the letter "L". The maximum incline for that level will be displayed in the INCLINE display and the maximum speed for that level will be displayed in the SPEED display and the MAX indicator lights will also be illuminated. You can adjust the level of intensity at any time

during your workout by pressing the   buttons.

### Step Ten:

Press the  button to begin your workout.

**TIP:** You can pause your workout by pressing the PAUSE  button. This feature is not available in cool down or heart rate control.

To resume, press the START  button.

# FAT BURN WORKOUT PROFILES

F2 THIGH SHAPER				
Level	Speed		Incline	
	Min	Max	Min	Max
1	1.4	2.2	0	1.5
2	2.0	2.8	0	2.0
3	2.6	3.4	0	2.5
4	3.2	4.0	0	3.0
5	3.8	4.6	0	3.5
6	4.4	5.2	0	4.0
7	5.0	5.8	0	4.5
8	5.6	6.4	0	5.0
9	6.2	7.0	0	5.5

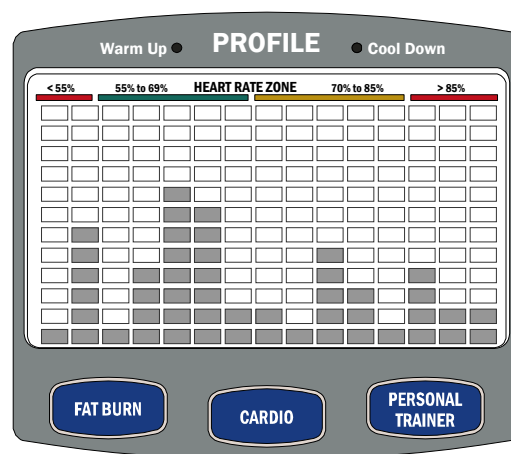

F2L4

F3 GLUTE TONER				
Level	Speed		Incline	
	Min	Max	Min	Max
1	1.2	2.8	0	12.5
2	1.6	3.2	0	12.5
3	2.0	3.6	0	12.5
4	2.4	4.0	0	12.5
5	2.8	4.4	0	12.5
6	3.2	4.8	0	12.5
7	3.6	5.2	0	12.5
8	4.0	5.6	0	12.5
9	4.4	6.0	0	12.5

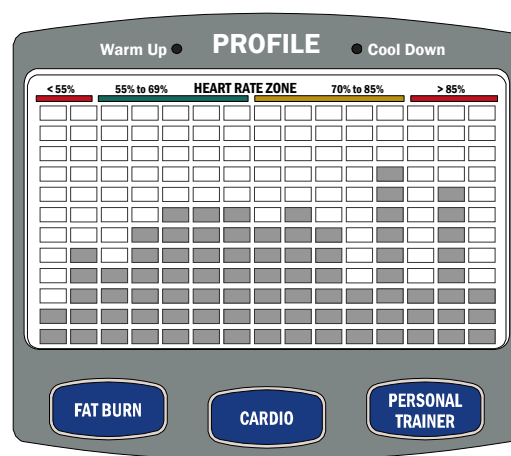

F3L4

F4 WAIST REDUCER				
Level	Speed		Incline	
	Min	Max	Min	Max
1	1.4	2.6	0	6.0
2	2.0	3.2	0	6.0
3	2.6	3.8	0	6.0
4	3.2	4.4	0	6.0
5	3.8	5.0	0	6.0
6	4.4	5.6	0	6.0
7	5.0	6.2	0	6.0
8	5.6	6.8	0	6.0
9	6.2	7.4	0	6.0

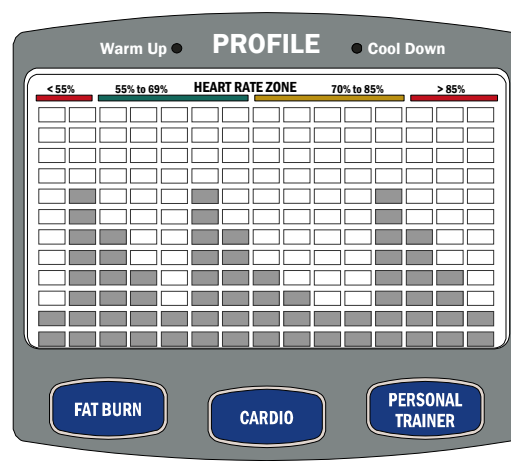

F4L4

**NOTE:** Your individual workout may differ slightly from the ones printed above, based on variables chosen by you, such as workout time and intensity level.

# CARDIO WORKOUTS

## TRAIN LESS AND BENEFIT MORE FROM YOUR WORKOUTS

To maximize the benefits from your workouts, you must maintain a sufficiently high heart rate. Target heart rate training takes the guesswork out of exercising. It provides you with the means to train within safe and effective ranges, all the while maximizing your exercise time and effort.

The PaceMaster Gold Elite has integrated heart rate control programs, which act as your personal trainer. You set your target based on your individual fitness goal (weight management or cardiovascular improvement), the time and maximum speed and incline parameters and the treadmill does the rest.

**TIP:** Based on the age entered, your PaceMaster treadmill automatically calculates your theoretical maximum heart rate and the Heart Rate Zone bar indicates which portion of your heart rate training zone (fat burn or aerobic) you are currently training. The fat burn zone is between 55% and 69% of your theoretical maximum heart rate. The aerobic zone is between 70% and 85% of your theoretical maximum heart rate.

The PaceMaster Gold Elite uses the Runners World standard formula to calculate your theoretical maximum heart rate. The formula uses  $\frac{1}{2}$  your age subtracted by 205. For example, if you are 40 years old, your theoretical maximum is 185 beats per minute (bpm). When your heart rate is between 102 and 128 bpm, you are training in the fat burn zone for weight management. When your heart rate is between 130 to 157 bpm, you are training in the aerobic training zone for cardiovascular improvement. The safest and most recommended method of determining your maximum heart rate is to have a physician administer a stress test.

## THE WIRELESS CHEST STRAP TRANSMITTER

The PaceMaster Gold Elite treadmill comes equipped with a **WIRELESS CHEST STRAP TRANSMITTER**, which, when worn, measures pulse (number of heart beats per minute) and relays the information by way of an electro-magnetic field to a receiver built into the treadmill's computer. This system is extremely accurate to within one beat per minute.

This chest strap must be worn to activate the HeartSmart™ Pulse Monitoring. The Heart Rate Control workouts are non-operational unless the chest strap is worn.

### PUTTING ON THE CHEST STRAP

To properly wear your chest strap, adjust the strap to fit snugly and comfortably around your chest with the electrodes (the grooved areas) directly over your sternum, as pictured to the right. For best results, the strap should be worn against skin. Moisture is necessary for the transmitter to function properly. Usually, perspiration is sufficient, but you may need to moisten the electrodes with water.

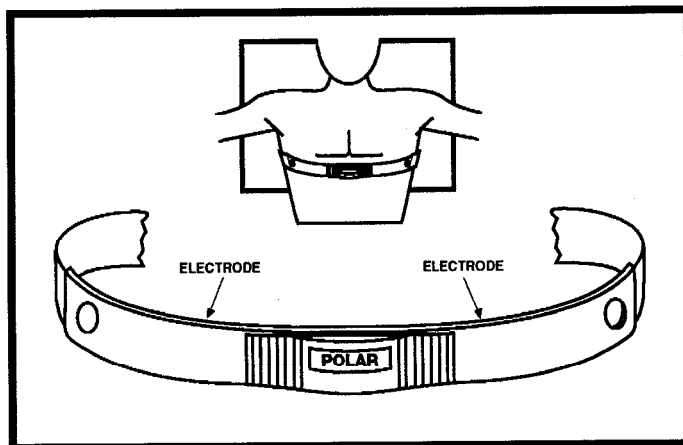

## CARDIO WORKOUTS

Your PaceMaster Gold Elite treadmill offers the following Heart Rate Control workouts:

- C1 - Heart Rate Monitor: Displays your heart rate and the training zone during workouts.
- C2 - Target HRC: Choose a heart rate training zone between 55% and 85% of your theoretical maximum.
- C3 - Fat Burn HRC: Choose one of five levels in the fat burn training zone, between 55% and 69% of your theoretical maximum.
- C4 - Cardio HRC: Choose one of five levels in the aerobic training zone, between 70% and 85% of your theoretical maximum.
- C5 - Interval HRC: The treadmill automatically alternates between 70% and 85% of your theoretical maximum.

**NOTE:** The PAUSE feature will not operate in ANY heart rate control program to avoid any undue cardiovascular stress.

## To begin using HEART ZONE MONITOR, TARGET HRC, FAT BURN HRC, CARDIO HRC and INTERVAL HRC (C1 through C5):

### Step One:





Put on the chest strap transmitter as pictured on page 21.

### Step Two:

Stand on the running belt and attach the garment clip on the end of the magnetic safety key to your clothing. Insert the safety key into its recess on the control panel.

**TIP:** If you have selected your user ID, go to Step Four.

### Step Three:

Press the Incline   buttons to set your weight and the Speed   buttons to set your age, then press the  button to store your personal information. You can now begin your desired program and the results; total Time, Distance, Calories burned, Aerobic Points earned and Average Speed, for seven workouts will be stored.

### Step Four:

Press the  button to select the desired CARDIO workout, C1 through C5 (C1-C5 will appear in the results window).

### Step Five:

Set the desired workout time using the  buttons.

### Step Six:

Press the  button.

**NOTE: The treadmill must be receiving a heart rate signal to proceed.** If no heart rate signal is being received, all displays go blank with the exception of the graphic display of the heart, and four dashes in the results window. Review "Putting on the chest strap" instructions on page 21.

### Step Seven:

The default max incline is 10.0% and the default max speed is 4.0 mph will appear in their corresponding windows and a target heart rate will appear in the RESULTS display window. Set the desired maximum speed using the SPEED buttons and the desired maximum incline by pressing the INCLINE buttons. **These parameters should be no faster or incline no higher than you feel comfortable reaching.** As a safety feature, your PaceMaster treadmill will **NEVER** exceed the speed and incline parameters you have set, even if they are not sufficient to get you to your target heart rate. **NOTE:** The treadmill will take you to your target based on your heart rate, not necessarily the speed and incline you entered. You will not reach the entered maximum speed and incline if your heart rate reaches the target at a lower speed and/or incline. Speed and incline changes can be made at any time during your workout.

### Step Eight:

Set the desired target Heart Rate by pressing the + or – WORKOUT INTENSITY LEVEL buttons.

- In C2 (Target HRC), you can choose a target heart rate from 55% to 85% of your theoretical maximum.
- In C3 (Fat Burn HRC), you can choose one of the five target heart rate zones optimal for weight management; from 55% to 69% of your theoretical maximum.
- In C4 (Cardio HRC), you can choose one of the five target heart rate zones optimal for aerobic training, from 70% to 85% of your theoretical maximum.
- In C5 (Interval HRC), you can adjust the intervals to any one of 5 settings. The treadmill automatically alternates your heart rate between 56% to 71%, 59% to 74%, 62% to 77%, 65% to 80%, or 68% to 83% of your theoretical maximum, in five minute timed intervals (2 minute @ high % and 3 minute @ low %).

### Step Nine:

Press the  button. After the warm up phase, you will see a graphic depiction of a heart and a ⊥ (the On-Target Indicator) in the PROFILE display window. When your heart rate is at the target the ⊥ (On-Target Indicator) will be centered under the heart depicted in

the Profile display. Correspondingly, when the heart rate falls below target the ⊥ (On-Target Indicator) will move to the left of center and if the heart rate exceeds the target the ⊥ (On-Target Indicator) will move to the right of center.

**TIP:** Because the warm up and cool down phases are an essential part of your workout, they cannot be deleted prior to beginning a Heart Rate workout. You will automatically advance into your main workout as soon as your heart rate reaches the target or at the end of the 5-minute warm up, whichever occurs first. If you choose to bypass the warm up phase, after you press the START button, you can proceed

into the main workout by pressing the  button once.

Your workout will end when the timer has counted down to zero or the STOP button has been pressed. The treadmill will display total time, current heart rate, calories expended, Aerobic Points earned, elapsed distance and average speed. The PROFILE display window will show a graphic review of your workout.

If a problem should occur, the treadmill can be stopped quickly by pulling on the magnetic safety cord to dislodge the key from the control panel. The treadmill will stop a bit more abruptly, but still gently enough to prevent you from being injured. **This is an emergency procedure only and should not be used as the normal stopping procedure.**

# Fitness Evaluator

Your PaceMaster Gold Elite Treadmill offers cardio program C6 a Fitness Evaluation. Thru the administration of a fitness test your treadmill can provide an estimation of your aerobic condition as well as analyzing the progress you make with training. The test is suitable for all fitness levels and provides a general classification of your aerobic condition based upon predicted VO2 max. This Fitness Evaluation consists of a 3 minute warm up and then a one mile walk/run/jog. Your heart rate upon the completion of one mile is recorded and factored along with age, gender and your one mile time (exclusive of warm up and cool down) to estimate your VO2 max. This is compared with VO2 max tables for the general public to arrive at a numerical score representing your estimated aerobic condition. The Fitness Evaluator test should be performed prior to your workout.

## Step One:





Put on the chest strap transmitter as pictured on page 21.

## Step Two:

Stand on the running belt and attach the garment clip on the end of the magnetic safety key to your clothing. Insert the safety key into its recess on the control panel.

**TIP:** If you have selected your user ID, go to Step Four.

## Step Three:



Press the Incline   buttons to set your weight and the Speed   buttons to set your age, then press the  button to store your personal information. You can now begin your desired program and the results; total Time, Distance, Calories burned, Aerobic Points earned and Average Speed, for seven workouts will be stored.

## Step Four:

Press the  button until C6 appears in the RESULTS window. A large "M" for male appears in the Profile display over the FAT BURN button and a large "F" for female appears in the Profile display over the PERSONAL TRAINER button. Press the FAT BURN button to choose male or press the PERSONAL TRAINER button to choose female.

**NOTE:** If no heart rate signal is being received all displays go blank with the exception of the Profile display of the one lap track and four dashes in the results window. To continue a heart rate signal is required. Review the chest strap installation instructions on page 21.

## Step Five:

Set your desired SPEED using the Speed   buttons. Choose a speed that will allow you to complete one mile at an easy, steady pace. For test purposes men should choose a speed **lower** than 7.5 mph (8 minute mile) and women should choose a speed **lower** than 6.7 mph (9 minute mile). Speed can be adjusted to these maximums during the test.

**NOTE:** All other buttons are non functional in this program.

## Step Six:

Press the  button to begin the test. A 3-minute warm up will begin and upon the completion of the warm up the one mile test will start. Upon the completion of the one mile test the cool down cycle automatically begins. Your Fitness Evaluation score will appear in the RESULTS display window. In as much as this program is designed for only testing purposes no other information is available in the RESULTS display window.

**NOTE:** Your Fitness Evaluation score can be classified into general fitness categories according to the following table:

<u>Very Poor</u>	<u>Poor</u>	<u>Fair</u>	<u>Good</u>	<u>Excellent</u>	<u>Superior</u>
Below 55	56-65	66-75	76-85	86-95	96-100

Analysis of the result is by comparing it with the result of previous tests. It is expected that, with appropriate training between each test, the analysis would indicate improvement.



# PERSONAL TRAINER WORKOUTS

The Gold Elite has six PERSONAL TRAINER workouts; three Interval courses and three Custom programs. The Hill, Speed and Mixed Interval programs, each with nine levels, were designed to improve your aerobic capacity by varying the intensity, enabling you to exercise harder, longer and burn more calories. The three CUSTOM programs give you the option to either create a personal program in advance or to create a personal program as you workout.

During your workout, you will be alerted to any speed and/or incline changes in the program with a series of visual and audible prompts. The current speed and or incline will flash to indicate a change. The new speed and/or incline will then be displayed.

To be certain you are receiving the maximum benefit from your workout, wear your wireless chest strap transmitter and activate the HeartSmart™ Pulse Monitoring System. The heart rate training zone in which you are currently exercising will be displayed on the Heart Rate Zone bar in the PROFILE display window. For details, refer to the HEARTSMART™ PULSE MONITORING SYSTEM section in this manual.





## Using Programs P1, P2, or P3:

### Step One:





Stand on the running belt and attach the garment clip on the end of the magnetic safety key to your clothing. Insert the safety key into its recess on the control panel.

**TIP:** If you have selected your user ID, go to Step Three.

### Step Two:



Press the Incline   buttons to set your weight and the Speed   buttons to set your age, then press the  button.

### Step Three:

Press the  button to select the desired program, P1, P2 or P3. **30:00 minutes** will flash in the TIME display window. Press the   buttons to set the desired workout time from 20:00 minutes to -1:00 (one hour) in 5 minute increments. Press the  button.

Note: The time displayed includes a 5 minute warm up and a 5 minute cool down phase. To eliminate the warm up and/or cool down phase(s), press the  button until the LED indicatory light(s) in the PROFILE display are no longer illuminated.

### Step Four:

The program number and intensity level (**P1L1**) will appear in the RESULTS display window. Select the level by pressing the   button until the desired level is displayed next to the program number. The maximum speed and incline for the selected level will appear in the SPEED and INCLINE windows. The MAX LED indicator lights will be illuminated. You can increase or decrease the level at any time during your workout.

### Step Five:

Press the  button to begin your program.

**TIP:** You can pause your workout by pressing the  button. This feature is not available in cool down or heart rate control.

To resume, press the  button.

If a problem should occur, the treadmill can be stopped quickly by pulling on the magnetic safety cord to dislodge the key from the Control Panel. The treadmill will stop a bit more abruptly, but still gently enough to prevent you from being injured. **This is an emergency procedure only and should not be used as the normal stopping procedure.**

## CUSTOM WORKOUTS (P4 Through P6)

The CUSTOM WORKOUTS offer three options:

- You can **USE** the factory set *Body For Life* recommended cardio interval workouts. (These programs can be recorded over and be recovered at any time.)
- You can **PROGRAM** a custom workout in advance of beginning your workout.
- You can **RECORD** a custom program as you workout.

To be certain you are receiving the maximum benefit from your workout, wear your wireless chest strap transmitter and activate the HeartSmart™ Pulse Monitoring System. The heart rate training zone in which you are currently exercising will be displayed on the Heart Rate Zone bar in the PROFILE display window. For details, refer to the HEARTSMART™ PULSE MONITORING SYSTEM section in this manual.





### To begin using P4 through P6 *Body For Life* recommended factory set programs:

#### Step One:

Stand on the running belt and attach the garment clip on the end of the magnetic safety key to your clothing. Insert the safety key into its recess on the control panel.

**TIP:** If you have selected your user ID, go to Step Three.

#### Step Two:

Press the Incline   buttons to set your weight and the Speed   buttons to set your age, then press the  button.

#### Step Three:

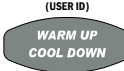
Press the  button to select the desired program, P4, P5 or P6. Press the  button to add a warm up and/or cool down.

#### Step Four:

Press the  button to begin your program.



**TIP:** You can pause your workout by pressing the  button. This feature is not available in cool down or heart rate control.

To resume, press the  button.

If a problem should occur, the treadmill can be stopped quickly by pulling on the magnetic safety cord to dislodge the key from the Control Panel. The treadmill will stop a bit more abruptly, but still gently enough to prevent you from being injured. **This is an emergency procedure only and should not be used as the normal stopping procedure.**

### To restore a *Body For Life* recommended cardio workout after it has been Programmed or Recorded over:

#### Step One:

Press the  button to select the program position you want to recover, P4, P5 or P6. Press and hold the  button until **rst** (restore) appears in the RESULTS window.





## To PROGRAM your own CUSTOM workout in advance of beginning your workout:

### Step One:



Stand on the running belt and attach the garment clip on the end of the magnetic safety key to your clothing. Insert the safety key into its recess on the control panel.

**TIP:** If you have selected your user ID, go to Step Three.









### Step Two:

Press the Incline   buttons to set your weight and the Speed   buttons to set your age, then press the  button.

### Step Three:

Press the  button to select the desired program position to create your workout, P4, P5 or P6. Press and hold the  button until **Prog** appears in the PROFILE display window. **1:00** minute appears in the TIME display window, **0.0%** appears in the INCLINE display window and **1.0** mph appears in the SPEED display window. **St 1** (step one) appears in the RESULTS display window.



### Step Four:

Adjust the desired time by press the   buttons, speed by pressing the Speed   buttons and incline by the Incline   buttons for Step 1, then press the  button. **St 2** will then appear in the RESULTS display window. Continue to enter the time, speed and incline and  for the desired number of steps. You can program up to 50 steps or segments in a minimum of 15 second intervals.

### Step Five:

After the workout data has been entered for all of the desired steps, press and hold the  button until **Stor** briefly appears in the RESULTS display window. The program profile will be displayed in the PROFILE display window, the total program time will be displayed in the TIME display window and the program's maximum speed and incline will appear in the INCLINE and SPEED display windows.

Press the  button to begin your program.

Note: The current distance will be displayed the RESULTS display window. To lock onto calories, Aerobic Points, Heart Rate (if wearing the chest strap transmitter and the CARDIO button was pressed prior to beginning the workout) or average speed, press the  button. An LED light will be illuminated next to the data currently appearing in the RESULTS display window. To scan your workout results while exercising, press and hold the  button until the word **SCAN** appears in the RESULTS display window. Each value will be displayed for 3 seconds.

Your workout will end when the timer has counted down to zero or the  button has been pressed. **Do not end your workout by removing the safety magnetic or your program will not be recorded.** The treadmill will display the total workout time, distance, calories, Aerobic Points and average speed. Your current heart rate will also be displayed, along with a graphic depiction of the Time Spent In Zone in the PROFILE display window, if the HeartSmart™ monitoring system was activated and the chest strap transmitter was worn.

If a problem should occur, the treadmill can be stopped quickly by pulling on the magnetic safety cord to dislodge the key from the Control Panel. The treadmill will stop a bit more abruptly, but still gently enough to prevent you from being injured. **This is an emergency procedure only and should not be used as the normal stopping procedure.**

## To RECORD a CUSTOM WORKOUT as you work out:

### Step One:

Stand on the running belt and attach the garment clip on the end of the magnetic safety key to your clothing. Insert the safety key into its recess on the control panel.



**TIP:** If you have selected your user ID, go to Step Three.

### Step Two:

Enter your weight and age as described in the OPERATING INSTRUCTIONS, SETTING YOUR WEIGHT AND AGE.

To monitor your heart rate, put on the chest strap transmitter and press the **CARDIO** button. **C1** will appear in the RESULTS display window. This activates the HeartSmart™ monitoring system.

### Step Three:

Press  button to select the desired program position to record your workout, P4, P5 or P6. Press the  button. **Rec** will appear in the PROFILE display window. The TIME display window will be **blank**, **0.0%** appears in the INCLINE display window and **1.0** mph appears in the SPEED display window.





### Step Four:

To set the starting speed and incline, press the Speed   buttons and the Incline   buttons until the desired settings appear in the corresponding display windows.

### Step Five:



When the desired time and starting speed and incline have been entered, press the  button to begin your workout.

### Step Six:

You can make up to a maximum of 50 changes for each workout by pressing the **Speed**   buttons and the **Incline**   buttons. Each time a change is made, **Rec** will appear in the PROFILE window indicating that the treadmill's computer is recording the change. As soon as the change has been recorded, **Rec** will disappear and another change can be made. Speed and

incline changes can be made simultaneously by using the **Speed**   and **Incline**   buttons or by using the  and  keys. For details, refer to EXPRESS KEYS in THE PACEMASTER GOLD ELITE CONTROL PANEL section of this manual.

Your workout will end when the  button has been pressed. **Stor** will appear in the RESULTS display window, indicating that you have successfully recorded your custom program. **Do not end your workout by removing the safety magnetic or your program will not be recorded.**

Note: The current distance will be displayed the RESULTS display window. To lock onto calories, Aerobic Points, Heart Rate (if wearing the chest strap transmitter and the **CARDIO** button was pressed prior to beginning the workout) or average speed, press the  button. An LED light will be illuminated next to the data currently appearing in the RESULTS display window. To scan your workout results while exercising, press and hold the  button until the word **SCAN** appears in the RESULTS display window. Each value will be displayed for 3 seconds.

If a problem should occur, the treadmill can be stopped quickly by pulling on the magnetic safety cord to dislodge the key from the Control Panel. The treadmill will stop a bit more abruptly, but still gently enough to prevent you from being injured. **This is an emergency procedure only and should not be used as the normal stopping procedure.**

# PERSONAL TRAINER WORKOUT PROFILES

P1 Hill Intervals				
Level	Speed		Incline	
	Min	Max	Min	Max
1	2.4	2.4	1.0	5.0
2	2.8	2.8	2.0	6.0
3	3.2	3.2	3.0	7.0
4	3.6	3.6	4.0	8.0
5	4.0	4.0	5.0	9.0
6	4.4	4.4	6.0	10.0
7	4.8	4.8	7.0	11.0
8	5.2	5.2	8.0	12.0
9	5.6	5.6	9.0	13.0

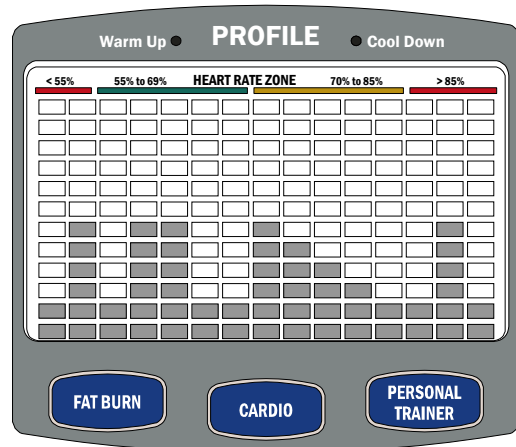

P1L4

P2 Speed Intervals				
Level	Speed		Incline	
	Min	Max	Min	Max
1	1.4	2.8	0	0
2	2.0	3.4	0	0
3	2.6	4.0	0	0
4	3.2	4.6	0	0
5	3.8	5.2	0	0
6	4.4	5.8	0	0
7	5.0	6.4	0	0
8	5.6	7.0	0	0
9	6.2	7.6	0	0

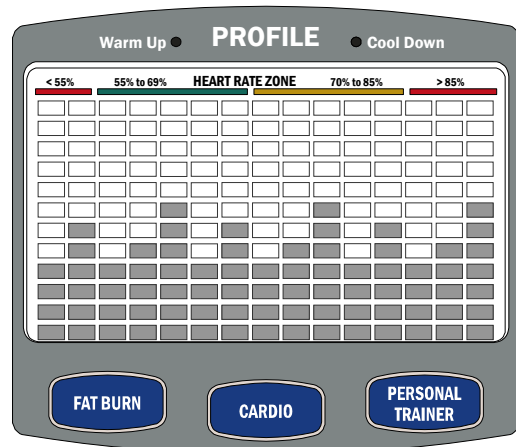

P2L4

P3 Mixed Intervals				
Level	Speed		Incline	
	Min	Max	Min	Max
1	1.6	2.8	0	6.0
2	2.2	3.4	0	6.0
3	2.8	4.0	0	6.0
4	3.4	4.6	0	6.0
5	4.0	5.2	0	6.0
6	4.6	5.8	0	6.0
7	5.2	6.4	0	6.0
8	5.8	7.0	0	6.0
9	6.4	7.6	0	6.0

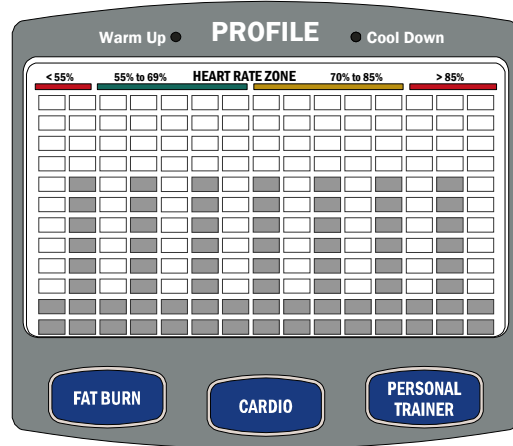

P3L4

**NOTE:** Your individual workout may differ slightly from the ones printed above, based on variables chosen by you, such as workout time and intensity level. Min and Max values above do not represent a warm up or cool down.

# EXCLUSIVE PACEMASTER FEATURES

## Exercise Preview

You can see exactly what you will accomplish prior to beginning a Timed Workout (Manual), or Variable Intensity Workout. An EXERCISE PREVIEW predicts the total distance, caloric expenditure and Aerobic Points to be earned based on the time, incline and speed you chose. After you have selected a Variable Intensity Workout, or have set the speed, time and incline parameters for a Timed Workout (Manual), the predicted calories, Aerobic points, and distance will be displayed in the RESULTS window. Press the SELECT button to change the displayed result. Note that any adjustments to speed, time and incline will change those figures.

## Aerobic Points

One of the main reasons people stop exercising is because they don't see the physical changes they expected. Results, however, can only be realized when you are training properly. For this reason, the Aerobic Point System has been incorporated into the design of PaceMaster treadmills since 1968.

The Aerobic Point System was developed by Dr. Kenneth Cooper, the Father of Aerobics and renowned founder of The Cooper Aerobics Center in Dallas, TX, to measure the aerobic benefit of the workout. Dr. Cooper's formula compares the energy costs of aerobic activity from the mathematical relationships between the oxygen expenditures assigned to each exercise at a given intensity and duration. This formula is built into the PaceMaster computer to automatically calculate the number of AEROBIC POINTS you earn for each workout

Dr. Cooper states in his book, *The Aerobics Program For Total Well Being*, "The main idea of this system is that, in order to stay in good shape and move toward a goal of total well-being, a person must earn a certain number of points each week by doing a certain amount of aerobic exercise." His research has determined that a man should **work up to** a minimum of 32 points per week and a woman should **work up to** a minimum of 27 points per week. The number of weekly points you earn correlates with your level of fitness. The fitness categories are:

Classification	Average Points per Week	
	Men	Women
Very Poor	Less than 10	Less than 8
Poor	10-20	8-15
Fair	21-31	16-26
Good	32-50	27-40
Excellent	51-74	41-64
Superior	75+	65+

If you have not been on a regular exercise program, it is highly recommended that you gradually work up to your desired fitness category and then develop a maintenance program.

You can see the number of AEROBIC POINTS you will earn prior to beginning your workout by pressing the SELECT button until Aerobic Points indicator is illuminated. To design a workout based on the number of AEROBIC POINTS you want to earn, follow the instructions below for PERSONAL ELECTRONIC TRAINER.

## Personal Electronic Trainer

Another feature exclusive to PaceMaster treadmills is the PERSONAL ELECTRONIC TRAINER. You can create a workout based on the number of Aerobic Points you want to earn or the number of calories you want to burn.

To create a workout based on Aerobic Points:

### Step One:

Determine how many times a week you will be exercising and how many weekly points you want to earn. For example, if you plan on exercising 4 times a week and your goal is to earn 32 points that week, you will need to earn 8 points per workout.





### Step Two:

Insert the safety key into its recess on the control panel.





## EXCLUSIVE PACEMASTER FEATURES (cont'd)

**TIP:** If you have selected your user ID, go to Step Four.

### Step Three:

Press the Incline   buttons to set your weight and the Speed   buttons to set your age, then press the  button to store your personal information. You can now begin your desired program and the results; total Time, Distance, Calories burned, Aerobic Points earned and Average Speed, for seven workouts will be stored.

### Step Four:

Enter the workout time using the   buttons until the desired workout time is displayed, you may also add a warm up and/or cool down by pressing  (USER ID) 

### Step Five:

Press the  button until the Aerobic Points indicator is illuminated.

### Step Six:

Enter speed. You will begin to see the number of Aerobic points you will earn in the RESULTS display as you increase the speed.

### Step Seven:

Enter Incline. You will begin to see the number of Aerobic points you will earn in the RESULTS display as you increase the speed.

**Note:** To create a workout based on calorie expenditure, select Calories in Step Four.

# Care and Maintenance

The following section describes necessary maintenance for your PaceMaster treadmill. This maintenance is the responsibility of the purchaser and is not covered under our warranty. Failure to perform this necessary maintenance could result in damage to your treadmill.

**⚠ CAUTION: Unplug your treadmill before attempting any cleaning or maintenance.**

## Deck and Tread Belt Cleaning

The running belt on your PaceMaster rides on a low friction, **maintenance-free** deck. Proper operation will be jeopardized if any water, dirt, solvents, fluids or abrasive materials come between the tread belt and the deck. For this reason, extra care must be used in keeping the belt clean. Use a soft, damp cloth to remove dust, dirt and other substances from the area between the belt and the side of the machine. Do not clean the tread belt by turning on the treadmill.

## Lubrication

The motor and roller bearings are sealed for maintenance free operation and require no lubrication. The deck and tread belt are lubricated at the factory and are also maintenance free. Any attempt to lubricate underneath the running belt could result in damage.

The side rails are made of steel. By occasionally applying a coat of automotive wax to them will help prevent rusting.

## Centering the Tread Belt

To improve belt life, the belt should be reasonably centered. To center the belt, walk on the treadmill at 2.5 mph for a few minutes. Determine whether the belt drifts too far to the left or right side. If adjustments are required, stop the treadmill and follow the steps listed below. Never make adjustments while the tread belt is moving.

**TIP:** If the tread belt is reasonably centered (no closer than 1/8" to the left or right deck shroud) no adjustments are necessary. Unnecessary adjustments can result in premature belt wear.

**⚠ CAUTION: Unplug your treadmill before attempting any cleaning or maintenance.**

### Step One: (figure 6)

If the belt is drifting to the left, using a 3/16" Hex wrench, turn the left-hand adjustment bolt (1) a quarter turn clockwise and the right-hand adjustment bolt (2) a quarter turn counter-clockwise.

If the belt is drifting to the right, using a 3/16" Hex wrench, turn the right-hand adjustment bolt (2) a quarter turn clockwise and the left-hand adjustment bolt (1) a quarter turn counter-clockwise.

### Step Two:

Walk on the belt for 1 minute, observing belt tracking. If the belt moves to one side, repeat step 1.

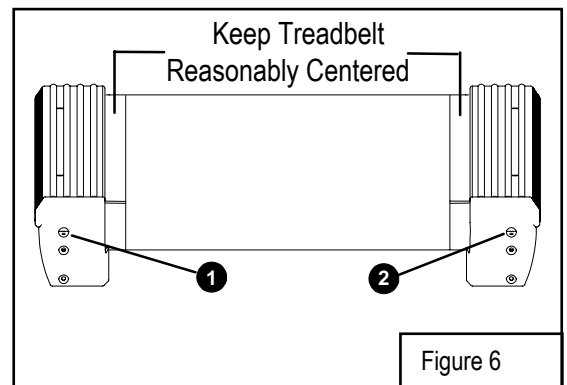



# TROUBLESHOOTING

**⚠ CAUTION: Unplug your treadmill before attempting any cleaning, maintenance, or service.**

No Power	Is the magnetic key inserted into the control panel?
	Is treadmill plugged into the wall outlet?
	Check the household circuit breaker to see if it is tripped. The treadmill <b>will not operate</b> if plugged into a GFCI (Ground Fault Current Interrupt) outlet.
	Check the treadmill circuit breaker (See Figure 8, page 35). If the circuit breaker is tripped, push reset button back in to reset.
	Make sure the wiring harness is plugged into the power supply (See Figure 2, page 6).
	Check both the black power cord and the black wiring harness for damage.

## Electronic Error Codes

Your self-diagnostic PaceMaster treadmill has built in sensors that will determine the precise reason for a problem. If the onboard computer detects a problem, an error code will be displayed. If an error code appears during operation of your treadmill, do the following:

- Make a note of the error code number (see next page for example).
- Obtain your serial number, located on the front of the treadmill approximately 10-12 inches to the left of the power cord.
- Write down which mode of operation you were using, the speed and incline that were set and if you were pressing any buttons at the time.
- Contact the PaceMaster dealer where you purchased your treadmill. If you have moved or need the name of the local dealer, visit our website at [www.pacemaster.com](http://www.pacemaster.com) and choose the dealer locator to find this information.

### Example Error Code

If the onboard computer detects a problem, an error code will be displayed. (Example - Err 149)  
 “Err” will display in the Time Window, “149” will display in Results Window (see example below).



# TROUBLESHOOTING (cont'd)

**! CAUTION:** Unplug your treadmill before attempting any cleaning, maintenance, or service.

## Error Code 117

This error will occur if the control panel is on and the user pushes the belt. If this error appears during a workout the user is manually pushing the belt faster than the set speed.

## Error Code 133 or 134

This is a communication error that could be a result of the black wire harness not being plugged in all the way. Unplug the treadmill from the wall outlet and reconnect the black wire harness that you plugged in during Step Two of assembly, see page 6.

## Error Code 149

Error code 149 indicates a button was pressed when the magnetic key was inserted into the control panel. Do not press down on any button when inserting the magnetic key. Make sure any accessories that are mounted to the control panel (book rack, etc.) are not making contact with the membrane.

## Error Code 298

Error Code 298 is an RPM signal code - indicates a loss of the RPM signal during a workout. Check all wiring connections (optical sensor and wiring harness) and all wiring for cuts or damage. (See Figure 2 page 6).

## Error Code 307

Indicates that there was no speed sensor signal at start up. Check the speed sensor connection and wiring.

## Error Code 425

After start is pressed, the tread belt does not move and then "Err 425" appears. To reset this error code you must unplug the treadmill from the wall outlet for 10 seconds, and then check the items listed below.

Check the drive motor wire connection to the power supply.

Check the ceramic fuse (20 Amp – 250 V) on the power supply.

## Elevation Error Codes

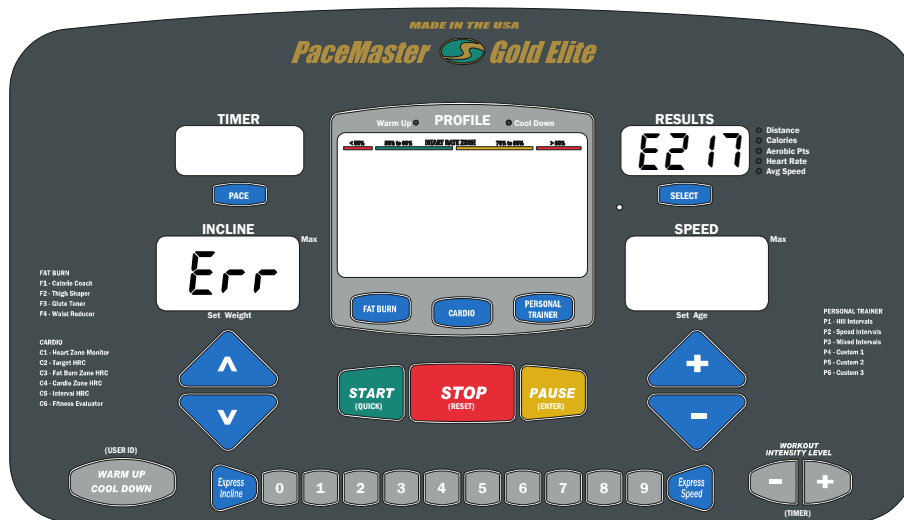

**"Err" in the Incline Display** - indicates a problem with the elevation system. Note: The treadmill will still function with the "Err" displayed in the incline Display, but the elevation system will not function. To determine the exact error code follow the procedure below.

Insert the magnetic key, **For the purpose of this test, DO NOT stand on the tread belt**

If "Err" appears in the incline display after pressing the Start/Quick, Stop/Reset, or Pause/Enter button, the control panel is not receiving an elevation reading. Start the treadmill and press the Up or Down Incline button, an "E 219" will appear in the Results Display. Check the both wiring connections between the elevation motor and the power supply. Also, check the wiring harness for cuts or visual damage.

If "Err" appears in the incline display after attempting an elevation change, the control panel did not see elevation movement. Touch the incline Up or Down button and an "E 217" will appear in the Data Window. Check the wiring connection between the elevation motor and the power supply. Check the elevation fuse to see if it has blown. If the fuse has blown, replace fuse.

## TROUBLESHOOTING (cont'd)

### Hesitation of the Tread belt

Hesitation of the tread belt usually indicates slippage of either the tread belt (the belt you walk on) or the drive belt (the belt connecting the drive roller to the motor). To determine which of these belts is slipping, first adjust the drive belt tension and test to see if the slippage stops. If the hesitation is not corrected than the tread belt tension needs adjustment.

 **CAUTION:** Unplug your treadmill before attempting any cleaning or maintenance.

### Drive Belt Tension Adjustment

#### Step One:

Use a Phillips head screwdriver to remove the 2 screws that hold the front of the motor cover in place and remove the motor cover.

#### Step Two: (figure 7)

Locate the four motor mount screws (item 1 in fig 7) as shown in the diagram and loosen them each two turns each using the 3/16" Hex wrench.

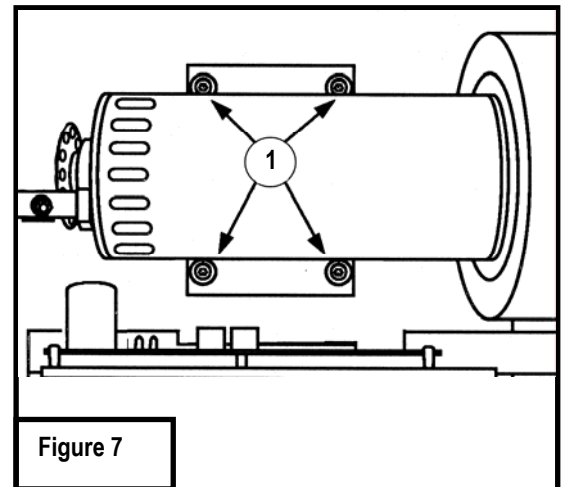

#### Step Three: (figure 8)

Locate the drive belt adjustment screw (item 2 in fig 8) in the lower front end of the treadmill. Insert the Hex wrench into the drive belt adjustment screw and turn the screw 1/2 turn clockwise.

#### Step Four: (figure 7)

Complete the adjustment by tightening the four motor mount screws (item 1 in fig 7).

#### Step Five:

Walk on the treadmill to determine if the slippage is decreased or eliminated.

#### Step Six:

If no improvement is observed, the hesitation may be caused by a loose tread belt - see "Tread belt tension adjustment" below. If improvement is noticed but slippage is still present, repeat steps 2 through 5. If you tighten the drive belt adjustment screw 1 1/2 turns and there is still hesitation (slippage) contact your authorized PaceMaster dealer. Tightening the drive belt adjustment screw more than 1 1/2 turns can result in bearing damage to the motor and/or drive roller.

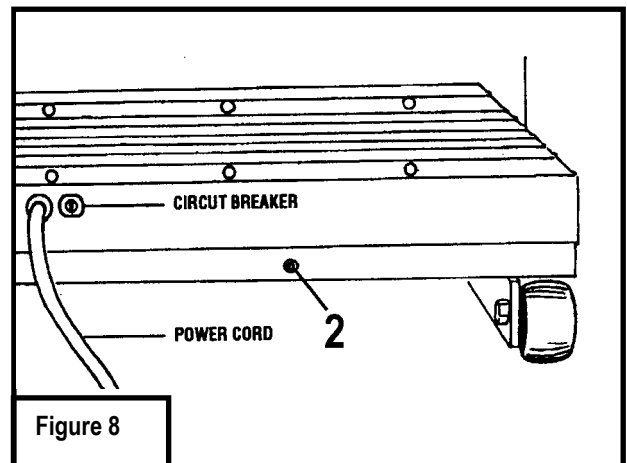

## TROUBLESHOOTING (cont'd)

### Tread Belt Tension Adjustment

#### Step One:

Locate the two tread belt adjustment screws (#1 & #2 in fig 9) as shown.

#### Step Two:

Turn both the left and right tread belt adjustment screws 1/2 turn clockwise.

#### Step Three:

Walk on the treadmill to see if the adjustment you made decreased the slippage.

#### Step Four:

If a significant decrease in slippage was observed, go to step 2. If you tighten the tread belt 1 1/2 turns per side and slippage is still present, do not continue to adjust the tread belt tension. Contact your authorized PaceMaster dealer.

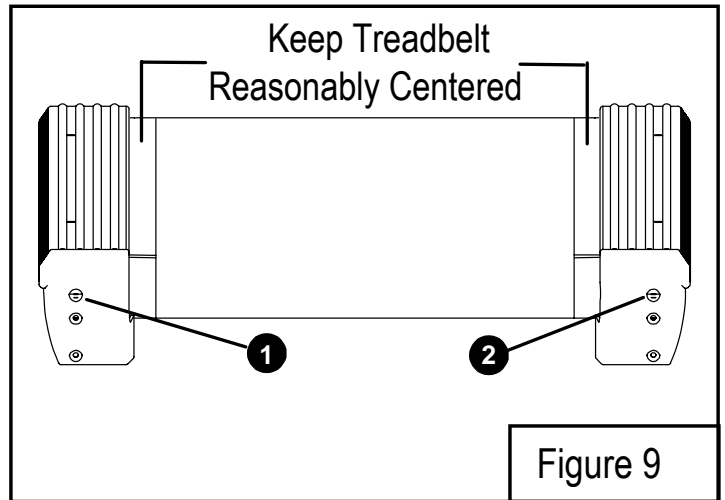

## FREQUENTLY ASKED QUESTIONS

- Q.** Why is time displayed as a negative number (i.e. - 1:15)?  
**A.** The treadmill's computer displays time in minutes and seconds (MM:SS) for workout times less than 1 Hour, and in hours and minutes (- H:MM) for workout times 1 hour or greater. - 1:15 represents one hour and 15 minutes.
- Q.** Why can't I change the speed in warm up or cool down?  
**A.** Warm up and cool down speeds are based on parameters recommended by the American College of Sports Medicine and cannot be overridden. To avoid undue cardiovascular stress, warm up begins at a lower percentage of the workout's starting speed and gradually takes you to the workouts starting speed. Conversely, cool down gradually reduces speed based on a percentage of the workouts ending speed.
- Q.** How do I find out the total hours and miles on my treadmill?  
**A.** Insert the magnetic safety key, when the "set weight" indicator begins to flash, press and hold the WORKOUT INTENSITY LEVEL + button the total time and mileage will appear in their respective windows and the power supply software version will appear in the INCLINE
- Q.** Can I eliminate warm up and/or cool down from a Variable Intensity Workout?  
**A.** Yes. If you wish to remove the warm up and/or cool down phases prior to starting your workout, press the WARM UP/COOL DOWN button until the corresponding indicator light is no longer illuminated. While in the warm up mode, press the Warm Up / Cool Down button and you will advance into the main phase of your workout. While in the main workout mode press the Warm Up / Cool Down button to advance to the cool down
- Q.** Why is dust accumulating behind and/or underneath my treadmill?  
**A.** This is normal. The dust is a combination of the PVC belt material and the phenolic deck surface as it wears.

# PaceMaster Gold Elite Technical Specifications

<b>Boxed Dimensions</b>	211 cm (83") L x 84 cm (33") W x 49 cm (19") H
<b>Assembled Dimensions</b>	186 cm (73") L x 82 cm (32") W x 137 cm (54") H
<b>Boxed Weight</b>	109 kg (239 lbs.)
<b>Assembled Weight</b>	93 kg (205 lbs.)
<b>Frame</b>	Welded aircraft grade extruded aluminum alloy
<b>Running Surface</b>	152 cm (60") L x 50 cm (20") W
<b>Drive Motor</b>	3.0 HP continuous duty DC
<b>Motor Manufacturer</b>	McMillan Electric
<b>Motor Control</b>	Digital PWM (Pulse Width Modulation)
<b>Elevation Motor</b>	1000 lb. thrust
<b>Belt</b>	Multi-ply polyester with static dispersing fibers, Texglide 6 lubricant.
<b>Deck</b>	Maintenance free custom designed medium density fiberboard
<b>Rollers</b>	64 mm (2.5") OD precision machined steel with permanently lubricated, sealed bearings
<b>Shock Absorption System</b>	Tri-Flex™ Low Impact Cushioning System
<b>Speed Range</b>	0.8 to 19.0 kph adjustable in 0.1 kph increments
<b>Elevation Range</b>	0 to 15% grade adjustable in 0.5% increments
<b>Workout Programs</b>	Quick Start, Manual, Fat Burn, Cardio, and Personal Trainer.
<b>Weight Limit</b>	400 lbs. (180 kilos)
<b>Warranty</b>	Lifetime Frame, 12 Years Motor, 5 Years Parts, 1 Year Labor
<b>Operating Temperature Range</b>	50° F (10°C) to 100° F (37° C)

Manufacturer reserves the right to change the products specifications without notice.

© Aerobics, Inc. 2004  
PaceMaster is a registered trademark of Aerobics Inc.